

High-Intensity Green LED in Plastic T-1³/₄ Package

OVLGG0Cx B9

- Narrow Beam Angle
- High Luminous Intensity
- Water Clear Plastic Package
- Green (525nm)

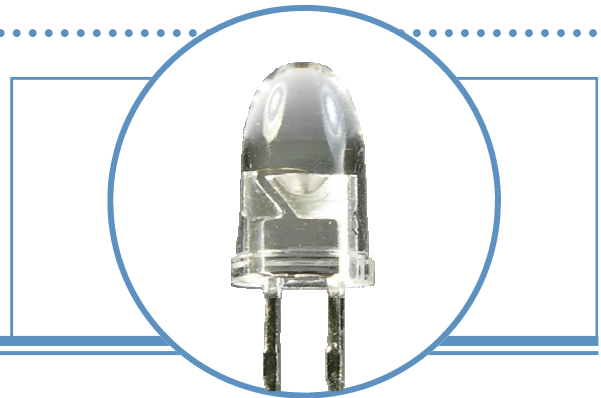

The OVLGG0Cx B9 is a high intensity InGaN LED mounted in a clear plastic T-1³/₄ package. The device incorporates an integral molded lens that enables a narrow beam angle and provides an even emission pattern. Designed to produce light over a wide range of drive currents, this LED is useful in applications requiring higher on-axis brightness than that achievable with standard lamps.

Applications

- Indoor/Outdoor Applications
- Message Boards
- Store Front Signage
- Indicators

Part Number	Material	Emitted Color	Intensity Typ. mcd	Lens Color
OVLGG0C4B9	InGaN	Green	4000	Water Clear
OVLGG0C5B9			5000	
OVLGG0C6B9			6300	

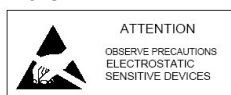
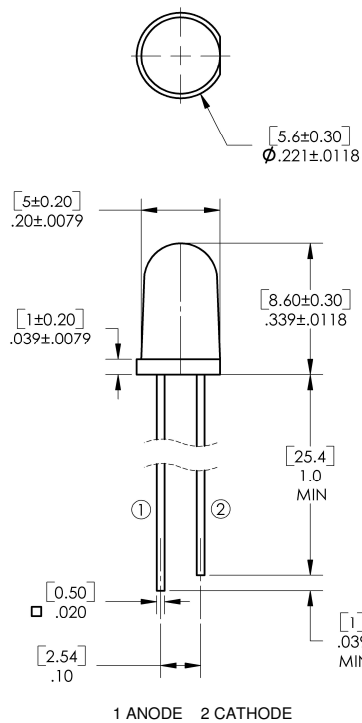

OPTEK reserves the right to make changes at any time in order to improve design and to supply the best product possible.

T-1 $\frac{3}{4}$ High-Intensity Green LED

OVLGG0CxB9



Absolute Maximum Ratings

$T_A = 25^\circ\text{C}$ unless otherwise noted

Storage Temperature Range	-40 ~ +100 °C
Operating Temperature Range	-40 ~ +85 °C
Reverse Voltage	5 V
Continuous Forward Current ²	25 mA
Peak Forward Current (10% Duty Cycle, 1KHz)	100 mA
Power Dissipation	100 mW
Lead Soldering Temperature (3mm from the base of the epoxy bulb) ¹	260 °C
Electrostatic Discharge	150 V

Note:

1. Solder time less than 5 seconds at temperature extreme.

Electrical Characteristics

$T_A = 25^\circ\text{C}$ unless otherwise noted

SYMBOL	PARAMETER	MIN	TYP	MAX	UNITS	CONDITIONS	
I_v	Luminous Intensity	x = 4	2500	4000	----	mcd	$I_F = 20\text{mA}$
		5	3200	5000	----		
		6	4000	6300	----		
V_F	Forward Voltage	----	3.5	4.0	V	$I_F = 20\text{mA}$	
I_R	Reverse Current	----	----	50	μA	$V_R = 5\text{V}$	
λ_P	Peak Wavelength	----	518	----	nm	$I_F = 20\text{mA}$	
λ_D	Dominant Wavelength	----	525	----	nm	$I_F = 20\text{mA}$	
$2\Theta_{\frac{1}{2}\text{H-H}}$	50% Power Angle	----	6	----	deg	$I_F = 20\text{mA}$	

Typical Electro-Optical Characteristics Curves

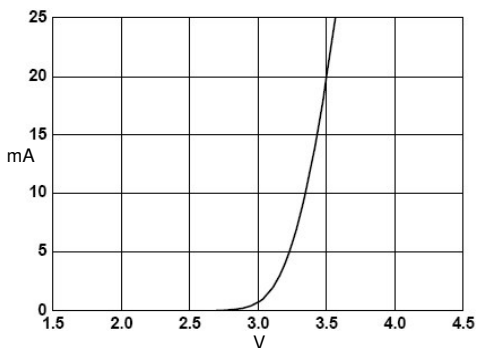

Forward Current vs. Forward Voltage

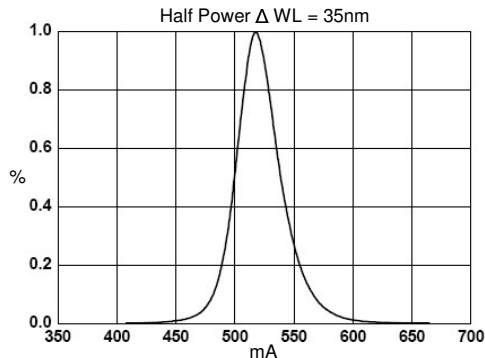

Relative Luminous Intensity vs. Wavelength

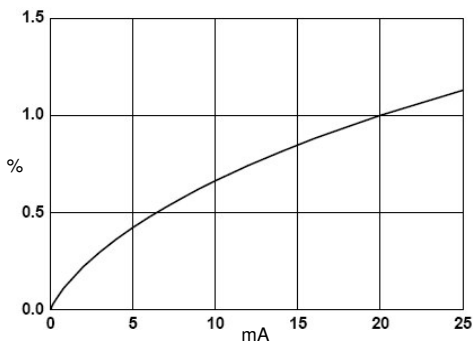

Relative Luminous Intensity vs. Forward Current

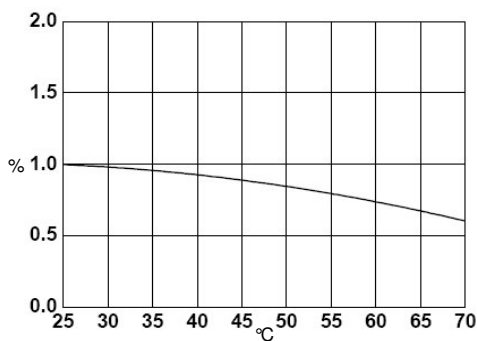

Relative Luminous Intensity vs. Ambient Temperature

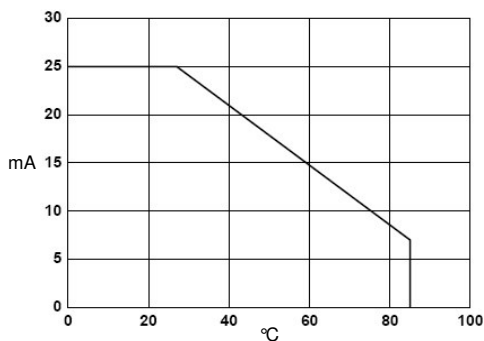

Forward Current vs. Ambient Temperature

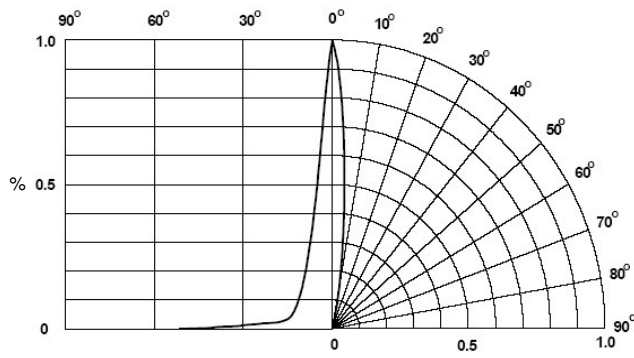

Relative Intensity vs. Radiation Angle

